

MPT-01
1.0" Border With 2.0" Radius
Black on Orange

8" LET. (SERIES B)	8" LET. (SERIES B)	8" LET. (SERIES B)
7.0 -	9.4 -	6.1 -
4.6 - C	4.8 - O	4.6 - 5
4.6 - R	4.9 - V	4.8 - 0
4.8 - O	4.2 - E	3.6 - 0
4.6 - S	3.3 - R	4.0 -
3.4 - S	9.4 -	3.8 - F
7.0 -	36.0	3.0 - T
36.0		6.1 -
		36.0

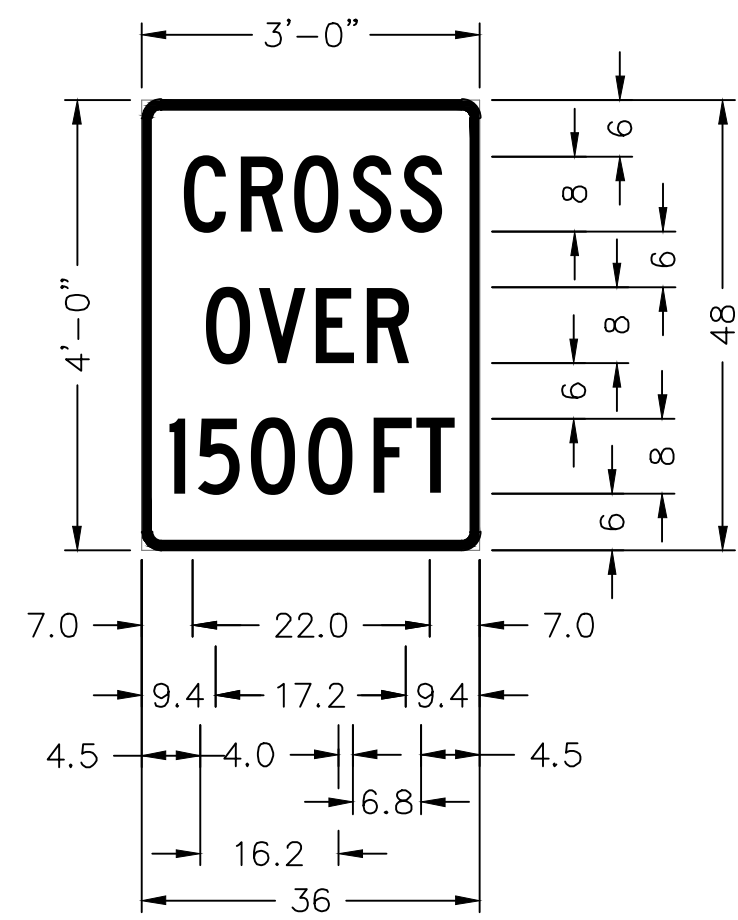

MPT-03
1.0" Border With 2.0" Radius
Black on Orange

8" LET. (SERIES B)	8" LET. (SERIES B)	8" LET. (SERIES B)
7.0 -	9.4 -	4.5 -
4.6 - C	4.8 - O	3.1 - 1
4.6 - R	4.9 - V	4.6 - 5
4.8 - O	4.2 - E	4.8 - 0
4.6 - S	3.3 - R	3.7 - 0
3.4 - S	9.4 -	4.0 -
7.0 -	36.0	3.8 - F
36.0		3.0 - T
		4.5 -
		36.0

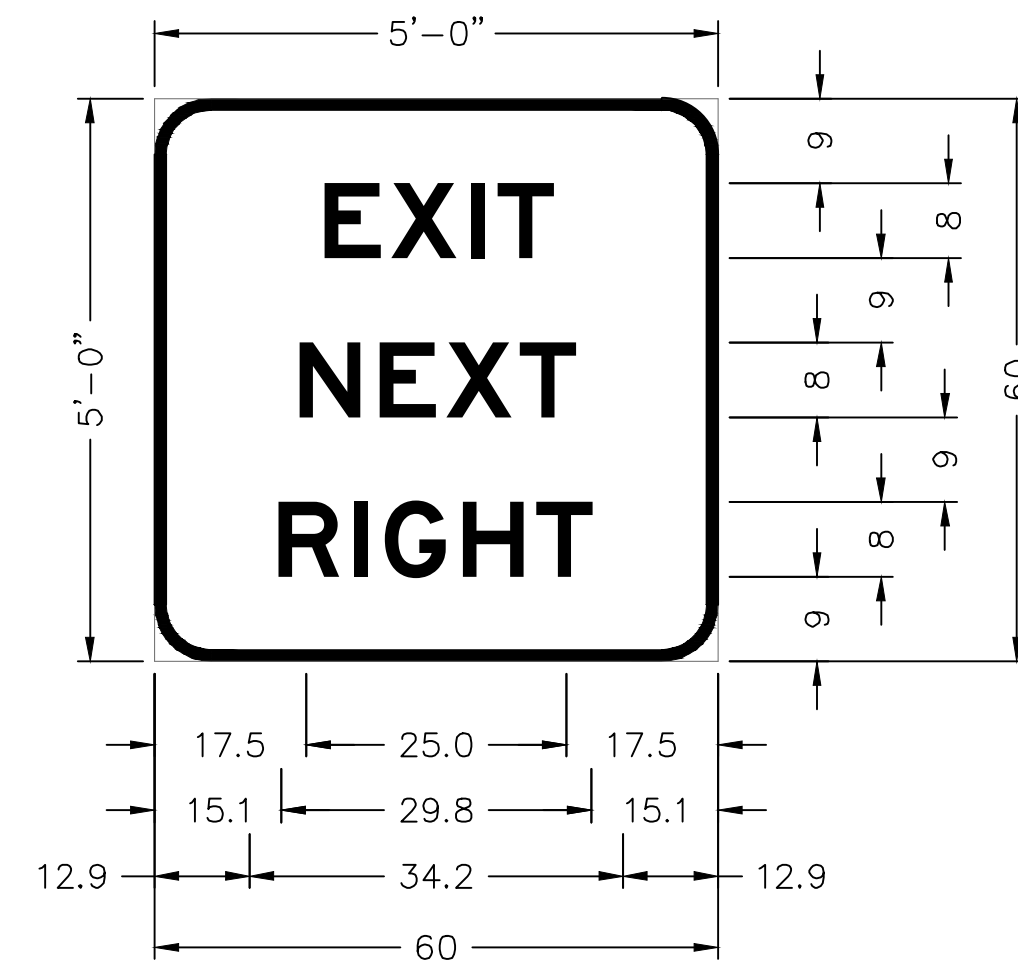

MPT-05
1.3" Border With 6.0" Radius
White on Green

8" LET. (SERIES E)	8" LET. (SERIES E)	8" LET. (SERIES E)
17.5 -	15.1 -	12.9 -
7.6 - E	8.4 - N	8.4 - R
8.5 - X	7.5 - E	3.5 - I
3.0 - I	7.9 - X	8.4 - G
5.9 - T	5.9 - T	8.0 - H
17.5 -	15.1 -	5.9 - T
60.0	60.0	12.9 -
		60.0

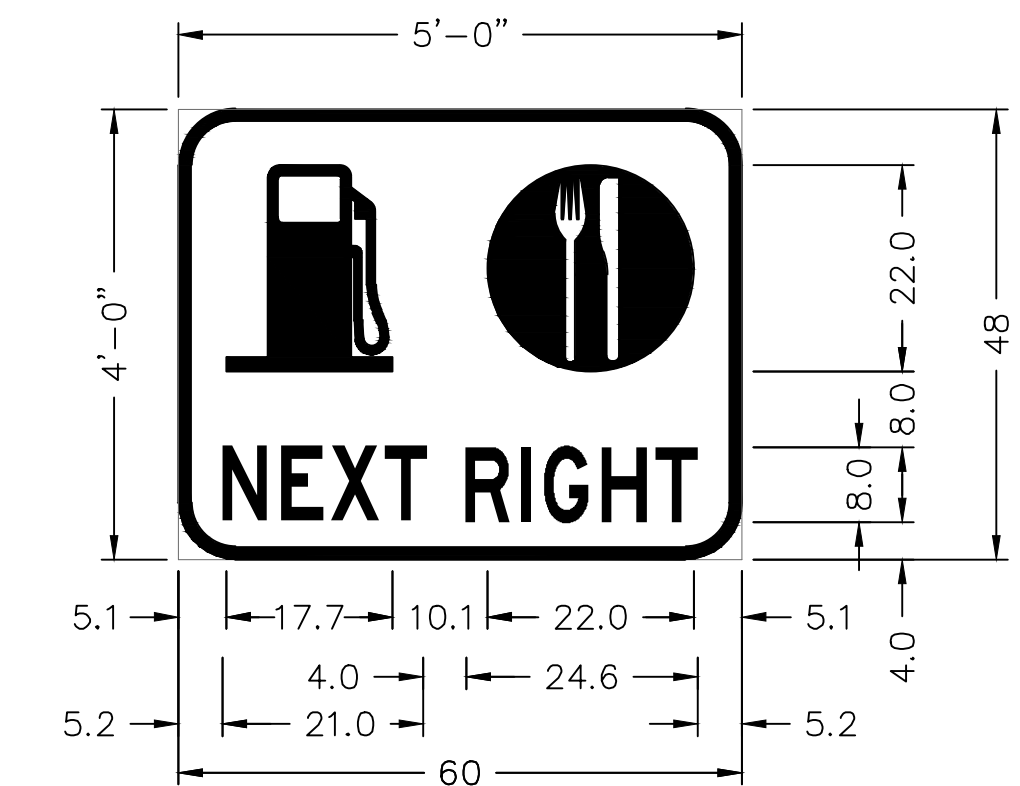

MPT-07
1.3" Border With 6.0" Radius
White on Blue

8" LET. (SERIES C)	8" LET. (SERIES C)
5.1 -	5.2 -
17.7 - FUEL	6.0 - N
10.1	5.4 - E
22.0 - FOOD	5.6 - X
5.1 -	4.0 - T
60.0	4.0 -
	6.0 - R
	2.8 - I
	6.1 - G
	5.7 - H
	4.0 - T
	5.2 -
	60.0

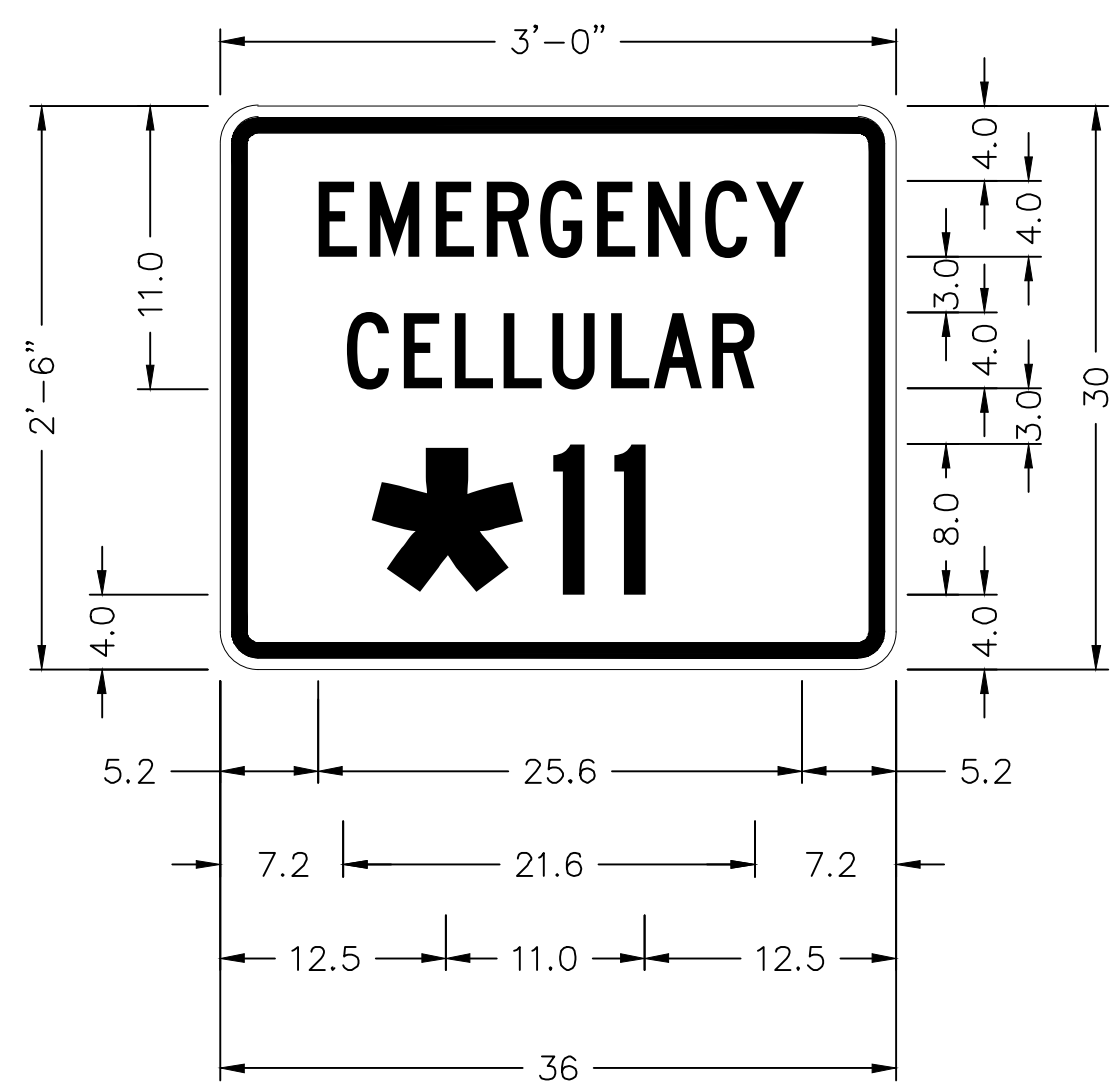

D12-14A
0.6" Margin With 0.8" Border
White on Blue
4" LET. (SERIES C)
8" LET. (SERIES C)

4" LET. (SERIES C)	4" LET. (SERIES C)	8" LET. (SERIES C)
5.2 -	7.2 -	10.0 -
2.7 - E	2.9 - C	11.0 - *
3.4 - M	2.7 - E	3.3 - 1
2.7 - E	2.7 - L	1.6 - 1
2.9 - R	2.6 - L	10.1 -
3.0 - G	3.1 - U	36.0
2.7 - E	2.2 - L	
3.0 - N	3.2 - A	
2.7 - C	2.2 - R	
2.5 - Y	7.2 -	
5.2 -	36.0	
36.0		

NOTE:
THE ACTUAL HEIGHT OF THE ASTERISK IN "*11"
IS 8 INCHES.

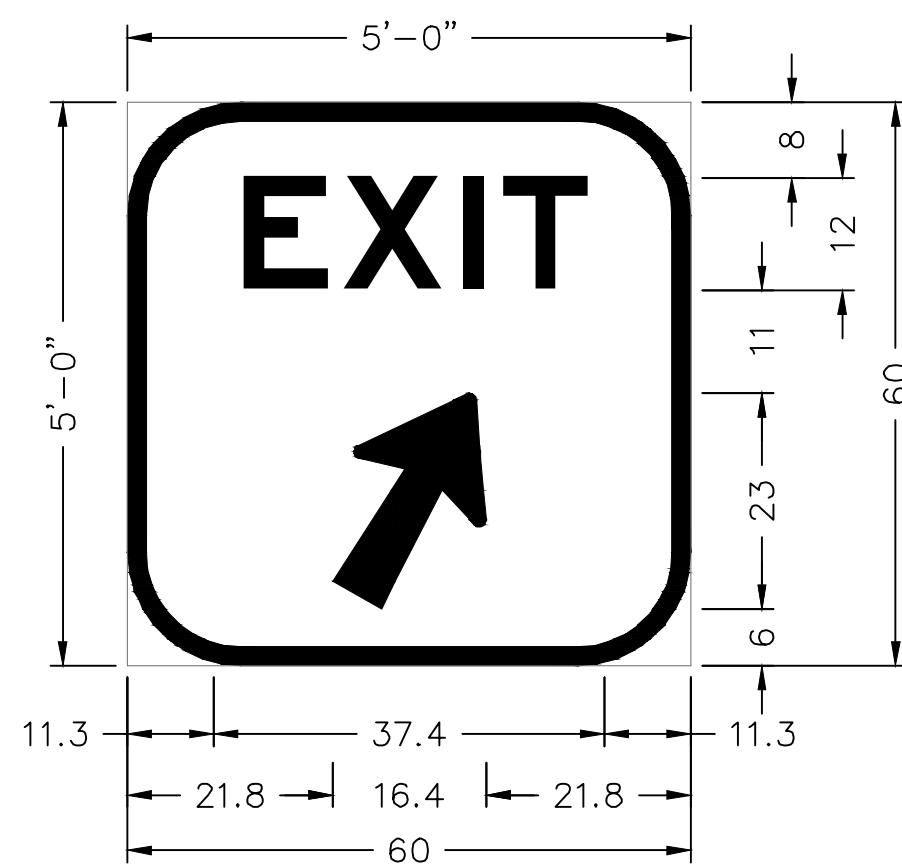

MPT-06
2.0" Border With 12.0" Radius
White on Green

12" LET. (SERIES E)	12" LET. (SERIES E)
11.3 -	21.8 -
11.3 - E	16.4 - ARROW
12.8 - X	21.8 -
4.5 - I	60.0
8.8 - T	
11.3 -	
60.0	

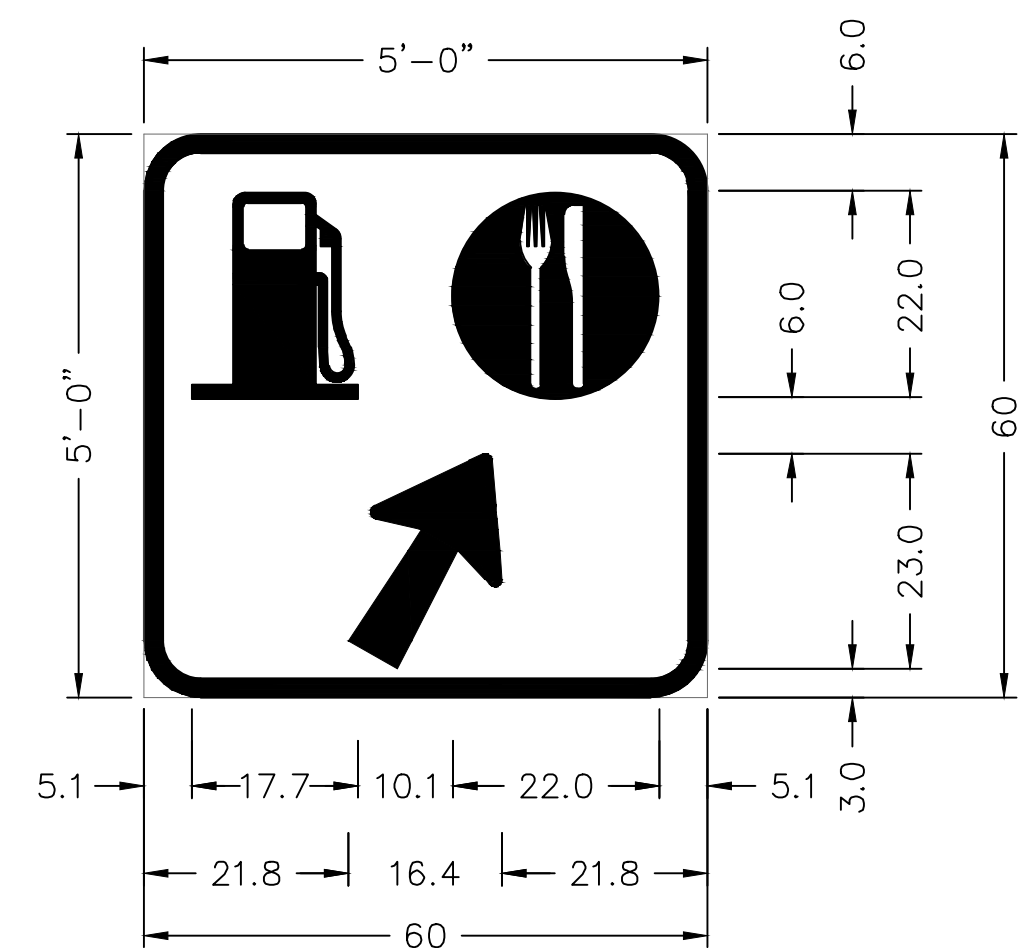

MPT-08
2.0" Border With 6.0" Radius
White on Blue

8" LET. (SERIES C)	8" LET. (SERIES C)
5.1 -	21.8 -
17.7 - FUEL	16.4 - ARROW
10.1	21.8 -
22.0 - FOOD	60.0
5.1 -	
60.0	

NOTES:
1. ALL SIGN DIMENSIONS ARE IN INCHES, UNLESS NOTED OTHERWISE.
2. SIGN SHOWN IS NOT TO SCALE.

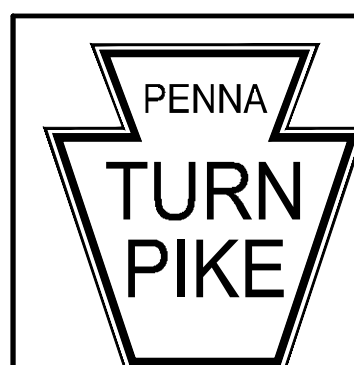

RECOMMENDED: DECEMBER 31, 2019
Gary L. Smith
 ASSISTANT CHIEF ENGINEER - DESIGN
 APPROVED: DECEMBER 30, 2019
[Signature]
 CHIEF ENGINEER

CONSTRUCTION AND MAINTENANCE
 MAINTENANCE AND PROTECTION OF TRAFFIC
 SIGN FABRICATION

PENNSYLVANIA TURNPIKE COMMISSION
 STANDARD DRAWING

FILE NAME: PTS-960-1.dwg	SHEET 1 OF 5
DRAWING TYPE: 5A	
DATE: DECEMBER 2019	PTS-960

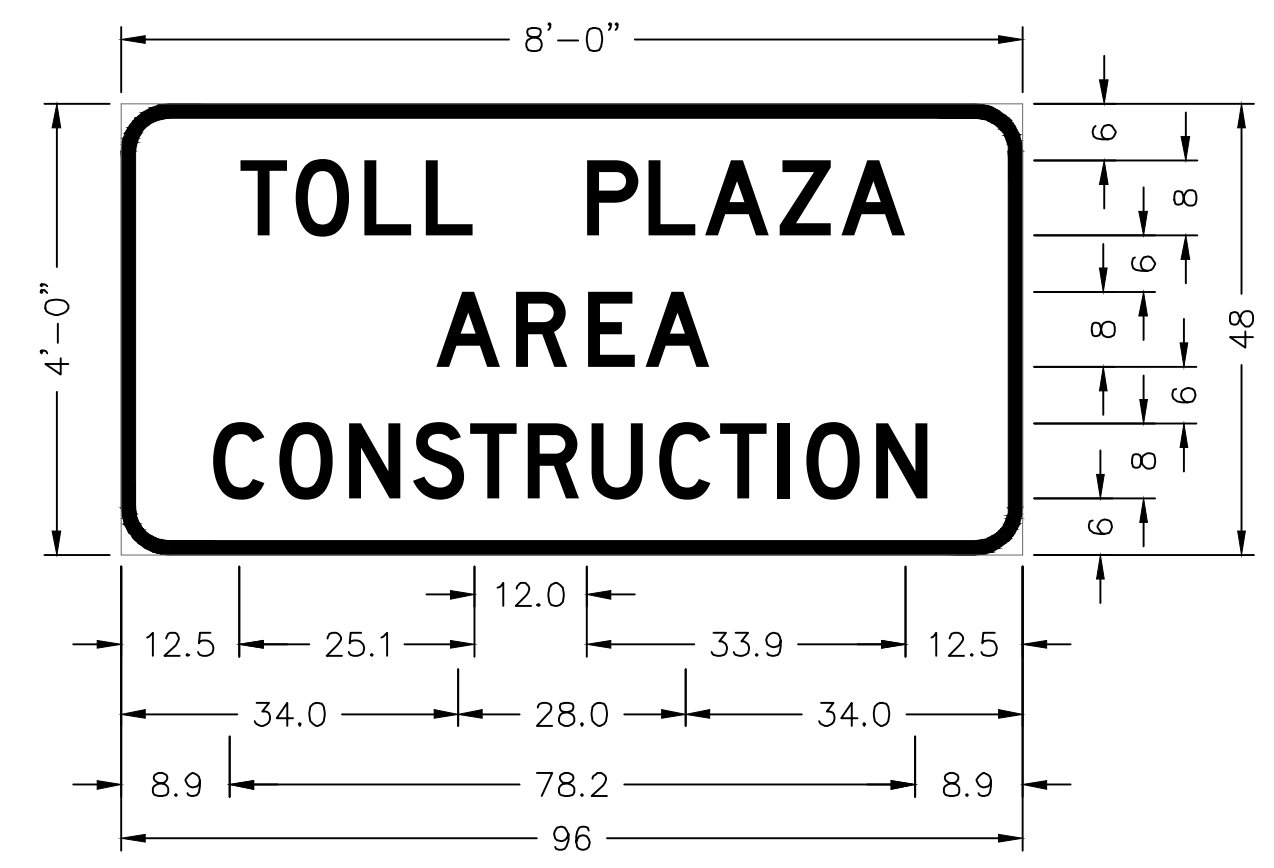

MPT-10

1.5" Border With 5.0" Radius
Black on Orange

8" LET. (SERIES D)	8" LET. (SERIES D)	8" LET. (SERIES D)
12.5 -	34.0 -	8.9 -
6.4 - T	8.2 - A	6.9 - C
7.5 - O	7.2 - R	7.5 - O
6.4 - L	5.9 - E	7.3 - N
4.8 - L	6.7 - A	6.8 - S
12.0 -	34.0 -	6.4 - T
7.3 - P	96.0	7.3 - R
5.4 - L		7.2 - U
8.1 - A		6.4 - C
6.4 - Z		6.4 - T
6.7 - A		3.1 - I
12.5 -		7.5 - O
96.0		5.4 - N
		8.9 -
		96.0

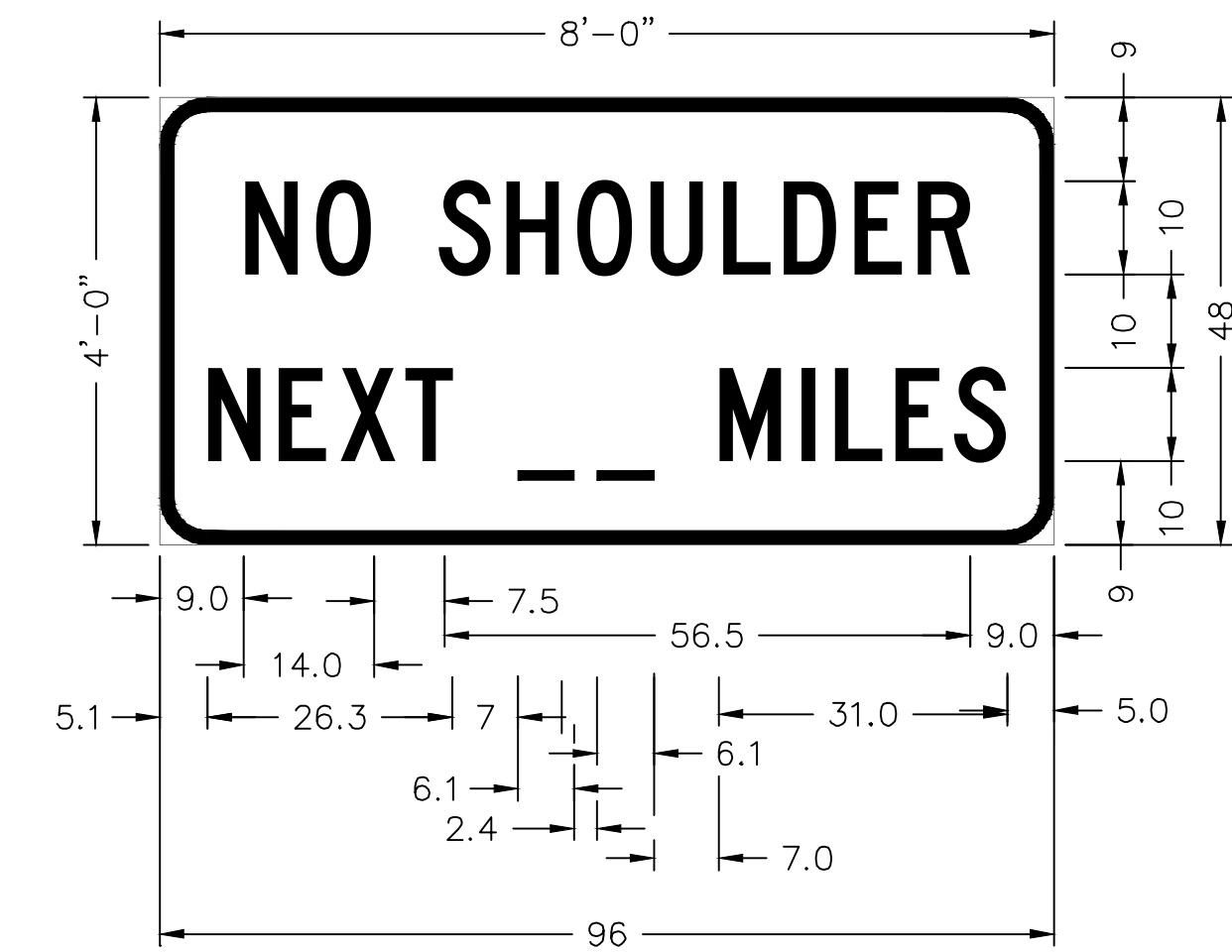

MPT-31

1.5" Border With 5.0" Radius
Black on Orange

10" LET. (SERIES C)	10" LET. (SERIES C)
9.1 -	5.7 -
7.5 - N	7.6 - N
5.8 - O	6.7 - E
7.5 -	7.0 - X
7.6 - S	5.0 - T
7.6 - H	*7.0 -
7.8 - O	13.3 -
7.6 - U	*7.0 -
6.7 - L	8.6 - M
7.6 - D	3.5 - I
6.7 - E	6.7 - L
5.4 - R	6.7 - E
9.1 -	5.5 - S
96.0	5.7 -
	96.0

* INDICATES
MINIMUM SPACING

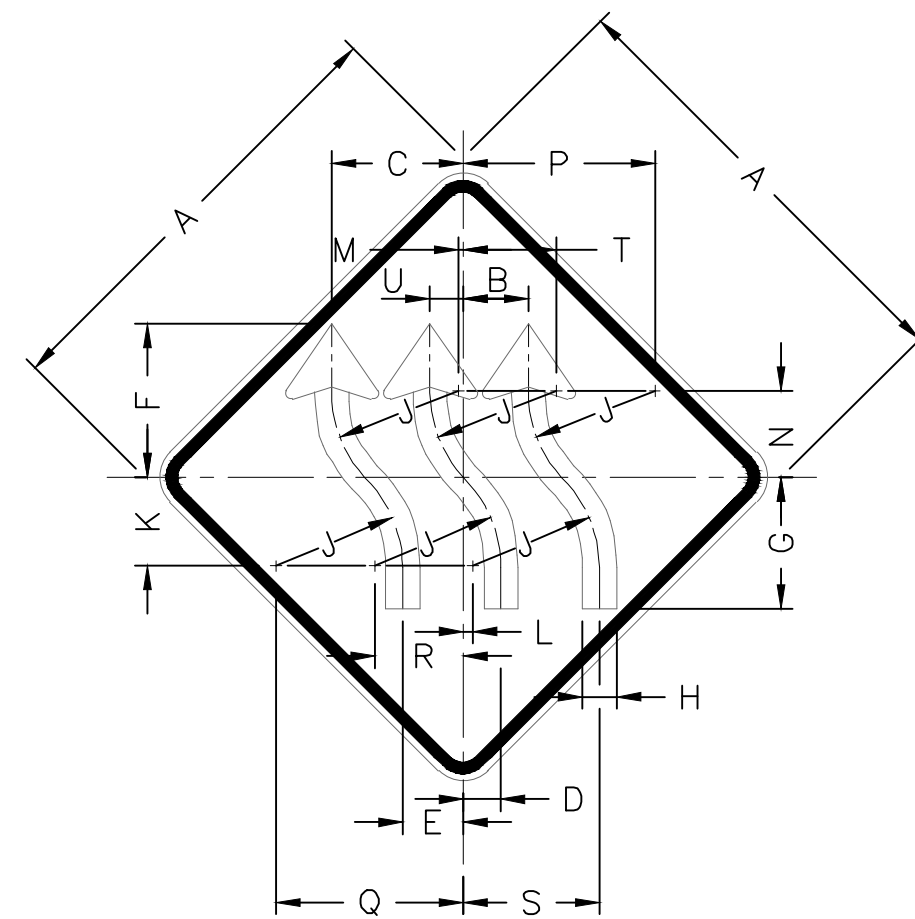

W1-4CL

SIGN SIZE	DIMENSIONS										
	A	B	C	D	E	F	G	H	J	K	L
48X48	48	7	13 ³ / ₁₀	4 ¹ / ₁₀	6 ⁷ / ₅	16 ³ / ₁₀	14	3 ³ / ₅	13 ² / ₅	9 ³ / ₅	1 ¹ / ₁₀

SIGN SIZE	DIMENSIONS							MARGIN	BORDER	BLANK STD.
	M	N	P	Q	R	S	T			
48X48	1/2	9	20 ² / ₅	19 ² / ₅	9 ² / ₅	14 ¹ / ₂	10	3 ¹ / ₂	1/8	B3-48

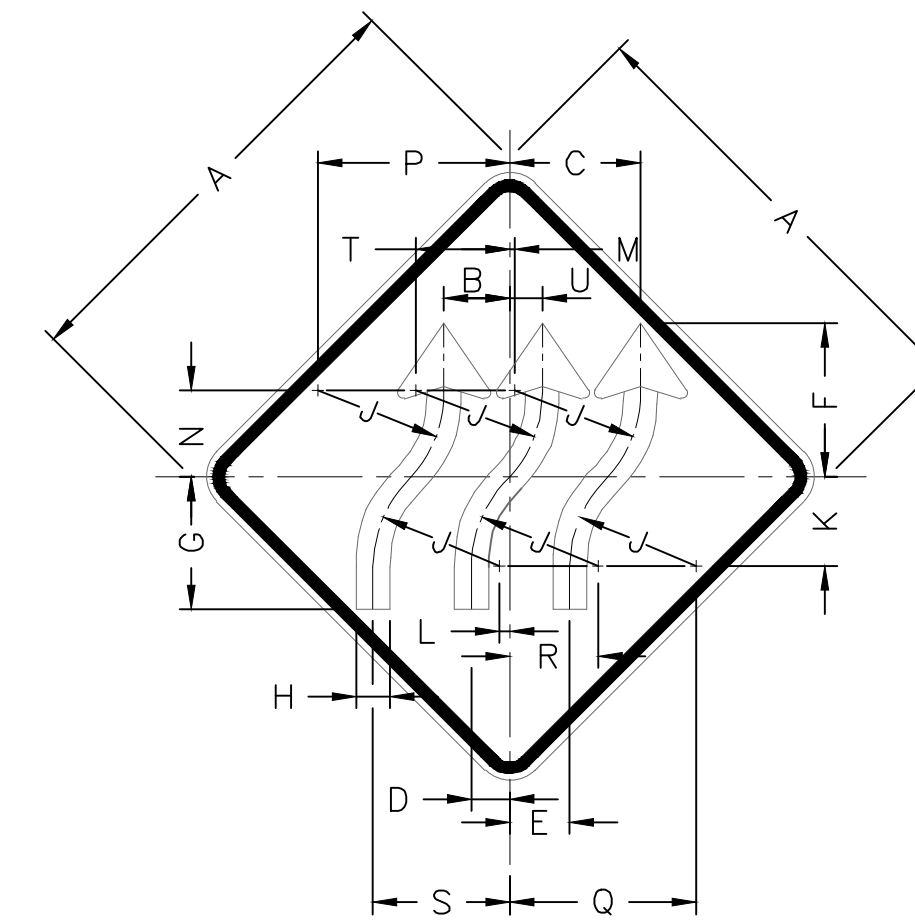

W1-4CR

SIGN SIZE	DIMENSIONS										
	A	B	C	D	E	F	G	H	J	K	L
48X48	48	7	13 ³ / ₁₀	4 ¹ / ₁₀	6 ⁷ / ₅	16 ³ / ₁₀	14	3 ³ / ₅	13 ² / ₅	9 ³ / ₅	1 ¹ / ₁₀

SIGN SIZE	DIMENSIONS							MARGIN	BORDER	BLANK STD.	
	M	N	P	Q	R	S	T				
48X48	1/2	9	20 ² / ₅	19 ² / ₅	9 ² / ₅	14 ¹ / ₂	10	3 ¹ / ₂	1/8	1/8	B3-48

- NOTES:
1. ALL SIGN DIMENSIONS ARE IN INCHES, UNLESS OTHERWISE NOTED.
2. SIGN SHOWN IS NOT TO SCALE.

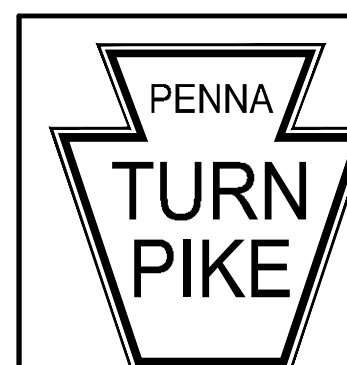

RECOMMENDED: DECEMBER 31, 2019
Gary L. Smith
 ASSISTANT CHIEF ENGINEER - DESIGN
 APPROVED: DECEMBER 30, 2019
[Signature]
 CHIEF ENGINEER

CONSTRUCTION AND MAINTENANCE
 MAINTENANCE AND PROTECTION OF TRAFFIC
 SIGN FABRICATION

PENNSYLVANIA TURNPIKE COMMISSION
 STANDARD DRAWING
 FILE NAME: PTS-960-2.dwg
 DRAWING TYPE: 5A
 SHEET 2 OF 5
 DATE: DECEMBER 2019
 PTS-960

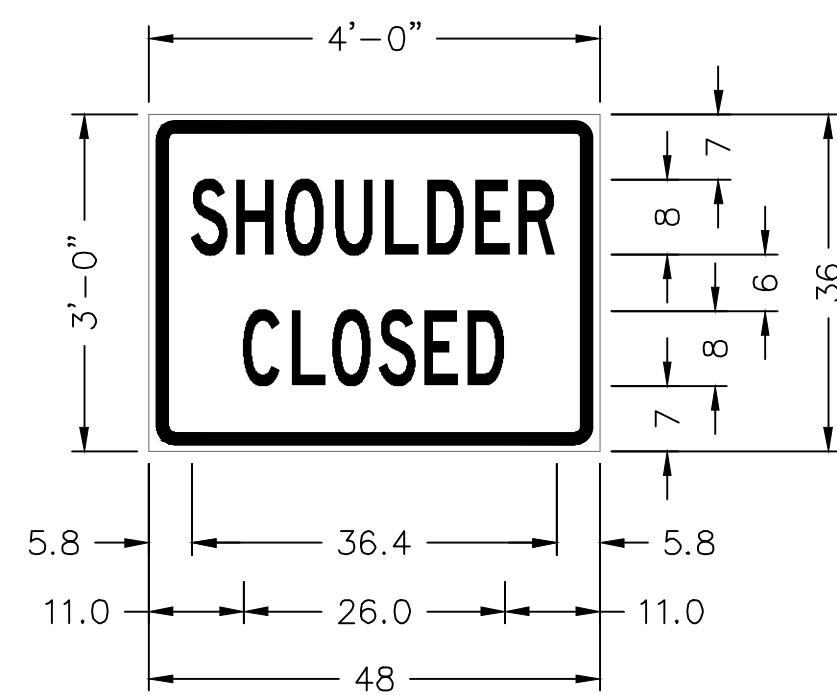

MPT-34
1.2" Border With 0.8" Radius
Black on Orange

8" LET. (SERIES B)	8" LET. (SERIES B)
5.8 -	11.0 -
4.9 - S	4.6 - C
4.9 - H	4.2 - L
5.1 - O	4.8 - O
4.8 - U	4.8 - S
4.2 - L	4.2 - E
4.9 - D	3.4 - D
4.2 - E	11.0 -
3.4 - R	48.0
5.8 -	
<u>48.0</u>	

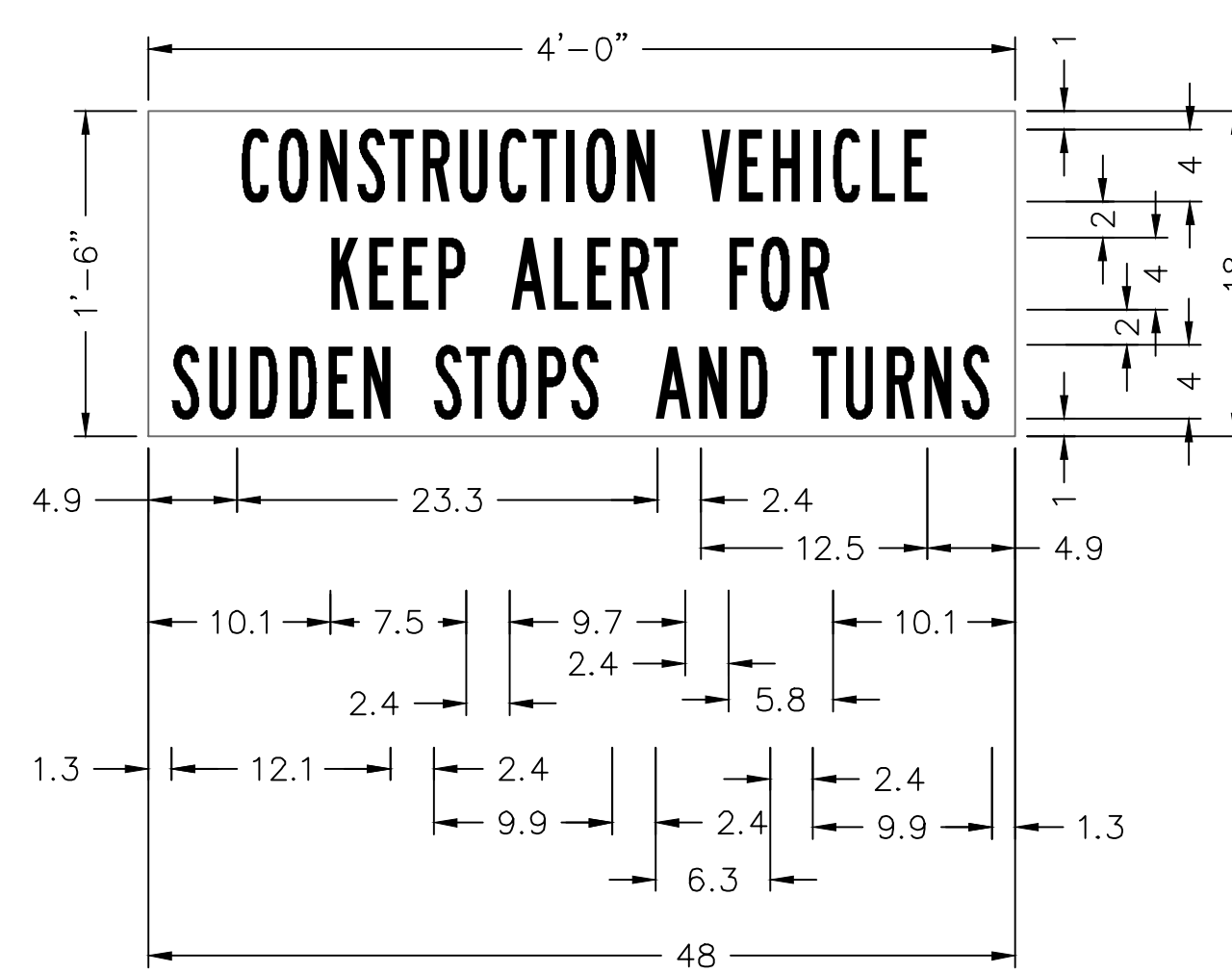

MPT-37
Black on Orange

4" LET. (SERIES B)	4" LET. (SERIES B)	4" LET. (SERIES B)
4.9 -	10.1 -	1.3 -
2.0 - C	2.1 - K	2.1 - S
2.3 - O	1.8 - E	2.1 - U
2.1 - N	1.9 - E	2.2 - D
2.1 - S	4.1 - P	2.1 - D
1.8 - T	2.5 - A	1.9 - E
2.2 - R	1.8 - L	4.1 - N
2.1 - U	1.9 - E	2.0 - S
1.9 - C	2.0 - R	1.9 - T
1.9 - T	3.9 - T	2.2 - O
0.9 - I	1.9 - F	2.1 - P
2.3 - O	2.3 - O	4.1 - S
4.1 - N	1.6 - R	2.4 - A
2.2 - V	10.1 -	2.2 - N
1.8 - E	48.0	4.1 - D
2.2 - H		1.8 - T
0.9 - I		2.2 - U
2.1 - C		2.1 - R
1.8 - L		2.1 - N
1.5 - E		1.7 - S
4.9 -		1.3 -
<u>48.0</u>		<u>48.0</u>

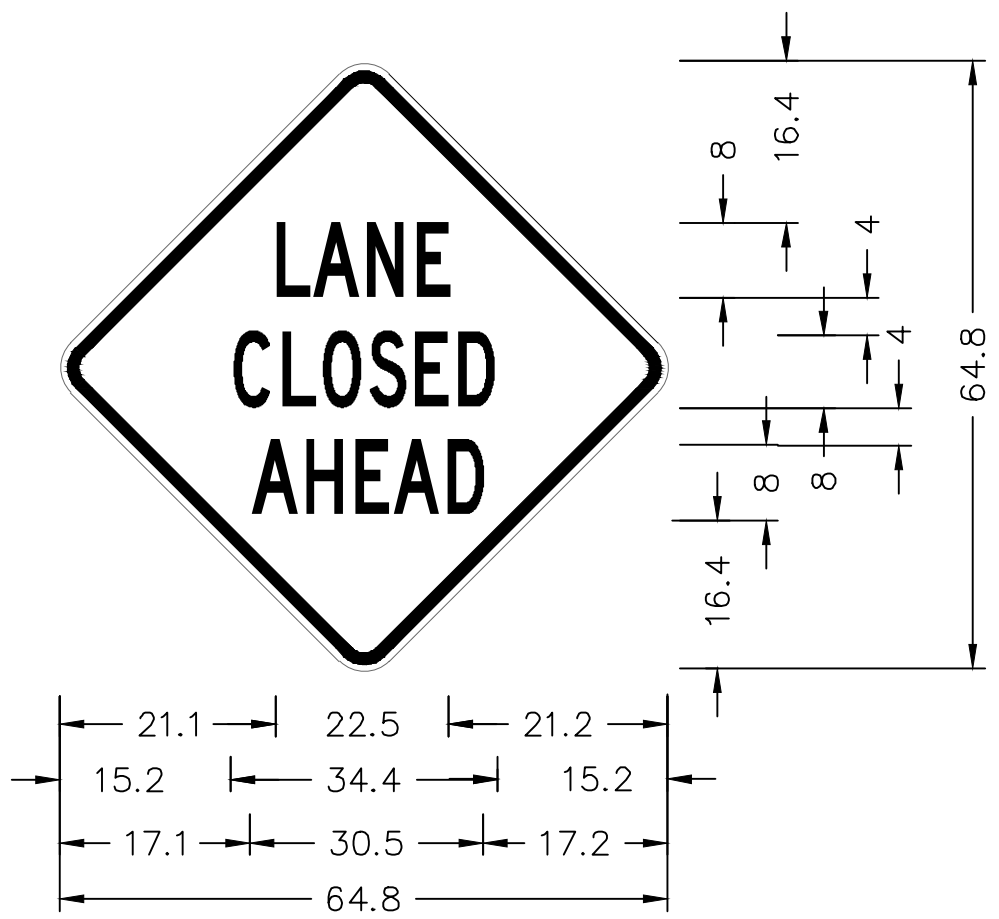

48" Across Sides, 0.9" Border, 0.6" Indent With 3.8" Radius
Black on Orange

PTC-LCA

8" LET. (SERIES D)	8" LET. (SERIES D)	8" LET. (SERIES D)
21.1 -	15.2 -	17.1 -
5.0 - L	5.9 - C	7.1 - A
6.9 - A	5.4 - L	5.8 - H
5.7 - N	6.2 - O	5.2 - E
4.9 - E	6.1 - S	7.0 - A
21.2 -	5.4 - E	5.4 - D
64.8	5.4 - D	17.2 -
	15.2 -	64.8
	<u>64.8</u>	

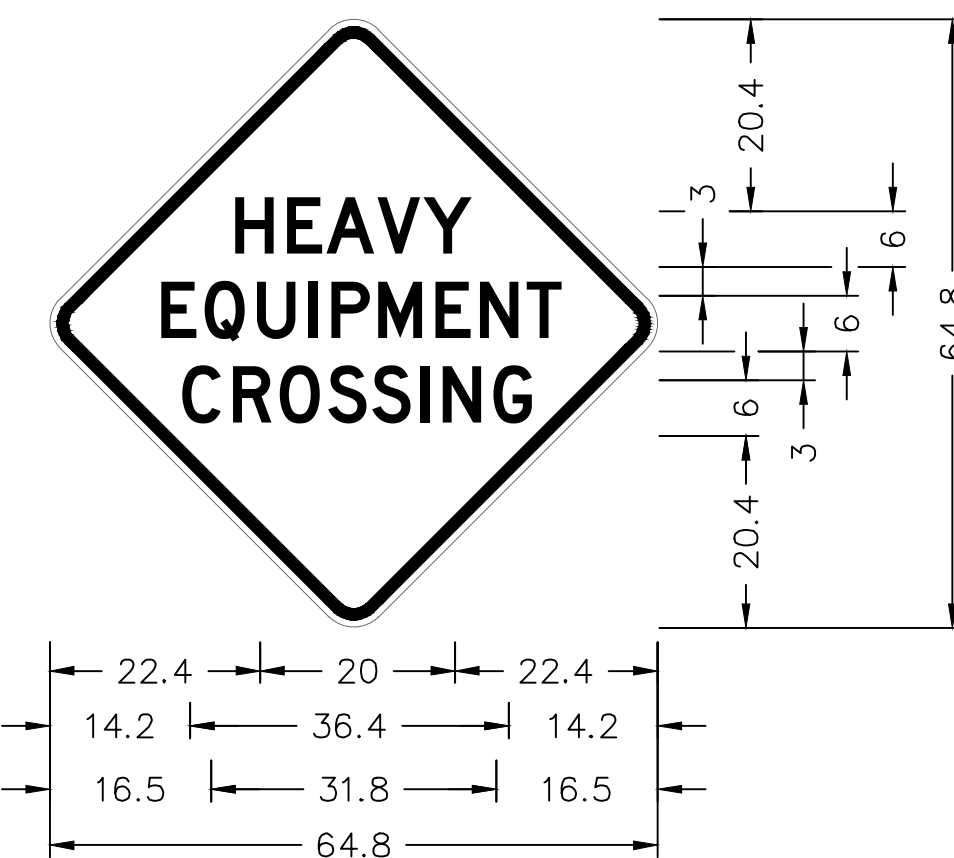

MPT-36
48" Across Sides, 0.8" Border, 0.4" Indent With 3.8" Radius
Black on Orange

6" LET. (SERIES C)	6" LET. (SERIES C)	6" LET. (SERIES C)
22.4 -	14.2 -	16.5 -
4.5 - H	4.0 - E	4.3 - C
3.7 - E	4.7 - Q	4.3 - R
4.1 - A	4.6 - U	4.4 - O
4.0 - V	2.1 - I	4.3 - S
3.7 - Y	4.5 - P	4.6 - S
22.4 -	5.2 - M	2.1 - I
64.8	4.0 - E	4.5 - N
	4.3 - N	3.3 - G
	3.0 - T	16.5 -
	14.2 -	64.8
	<u>64.8</u>	

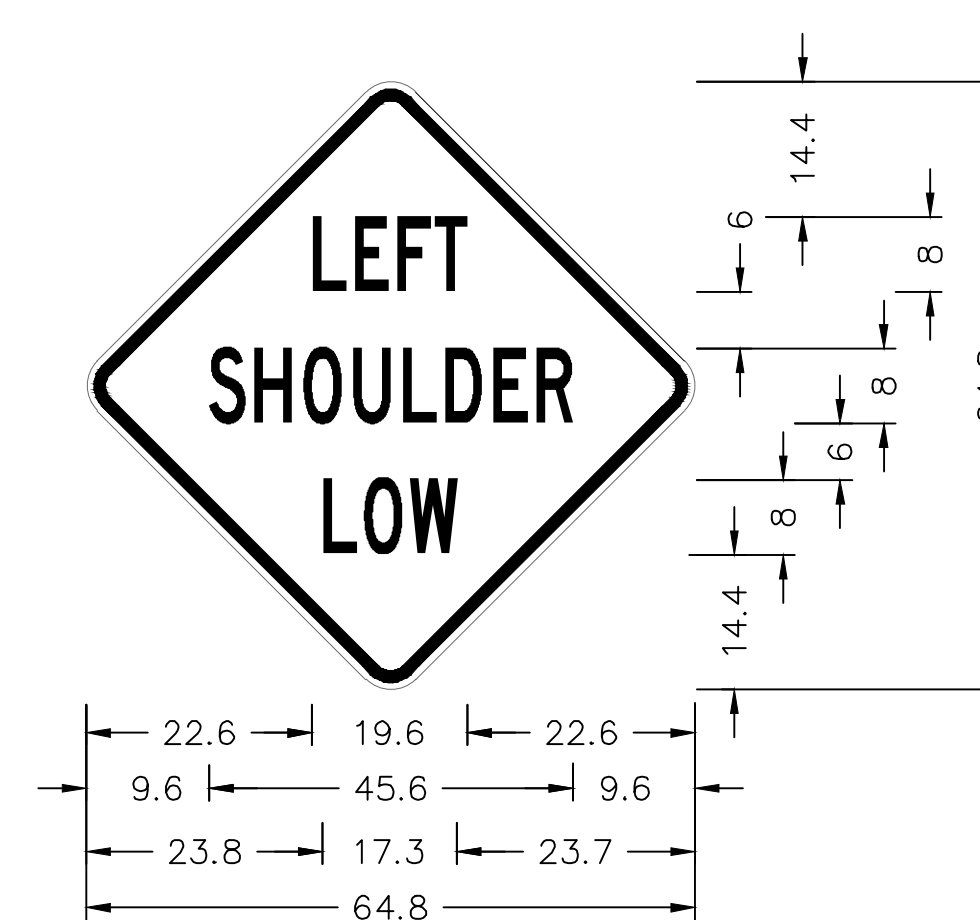

MPT-38
48" Across Sides, 0.8" Border, 0.4" Indent With 3.8" Radius
Black on Orange

8" LET. (SERIES C)	8" LET. (SERIES C)	8" LET. (SERIES C)
22.6 -	9.6 -	23.8 -
5.3 - L	6.0 - S	5.4 - L
5.4 - E	6.1 - H	5.9 - O
4.9 - F	6.3 - O	6.0 - W
4.0 - T	6.0 - U	23.7 -
22.6 -	5.4 - L	64.8
64.8	6.1 - D	
	5.3 - E	
	4.4 - R	
	9.6 -	
	<u>64.8</u>	

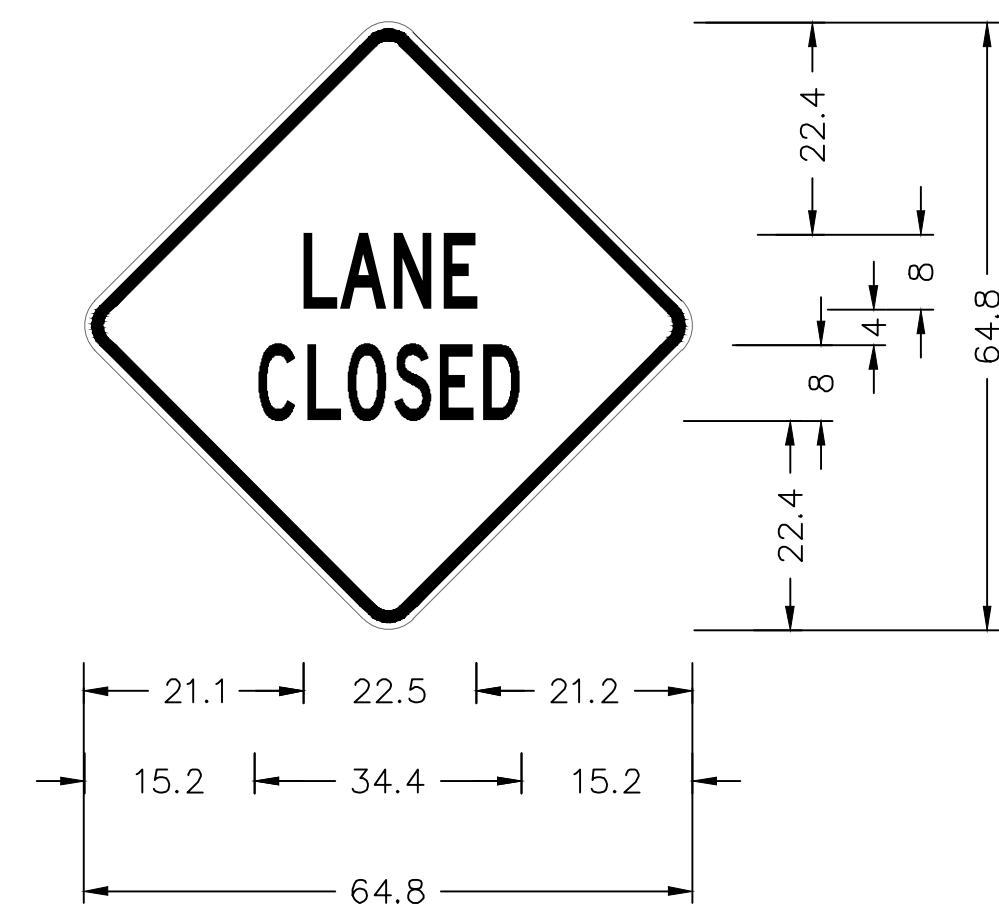

48" Across Sides, 0.9" Border, 0.6" Indent With 3.8" Radius
Black on Orange

PTC-LC

8" LET. (SERIES D)	8" LET. (SERIES D)
21.1 -	15.2 -
5.0 - L	5.9 - C
6.9 - A	5.4 - L
5.7 - N	6.2 - O
4.9 - E	6.1 - S
21.2 -	5.4 - E
64.8	5.4 - D
	15.2 -
	<u>64.8</u>

NOTES:
1. ALL SIGN DIMENSIONS ARE IN INCHES, UNLESS NOTED OTHERWISE.
2. SIGN SHOWN IS NOT TO SCALE.

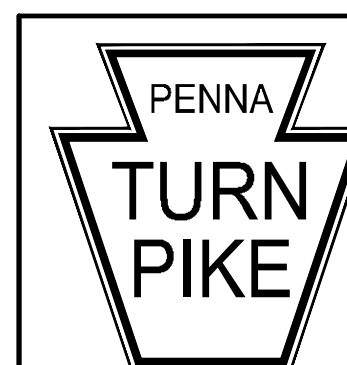

RECOMMENDED: DECEMBER 31, 2019
Gary L. Smith
 ASSISTANT CHIEF ENGINEER - DESIGN
 APPROVED: DECEMBER 30, 2019
[Signature]
 CHIEF ENGINEER



**CONSTRUCTION AND MAINTENANCE
 MAINTENANCE AND PROTECTION OF TRAFFIC
 SIGN FABRICATION**

**PENNSYLVANIA TURNPIKE COMMISSION
 STANDARD DRAWING**

FILE NAME: PTS-960-3.dwg	SHEET 3 OF 5
DRAWING TYPE: 5A	
DATE: DECEMBER 2019	PTS-960

TABULATION OF MPT SIGNS

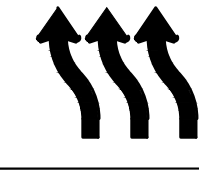
SIGN	SIZE	LEGEND	BACK-GROUND	COPY	BORDER	ARROWS
D12-14A	3' x 2.5'	EMERGENCY CELLULAR *11	BLUE	WHITE	WHITE	_____
MPT-01	3' x 4'	CROSSOVER 500 FT	ORANGE	BLACK	BLACK	_____
MPT-03	3' x 4'	CROSSOVER 1500 FT	ORANGE	BLACK	BLACK	_____
MPT-05	5' x 5'	EXIT NEXT RIGHT	GREEN	WHITE	WHITE	_____
MPT-06	5' x 5'	EXIT 	GREEN	WHITE	WHITE	WHITE
MPT-07	5' x 4'	 NEXT RIGHT	BLUE	WHITE	WHITE	_____
MPT-08	5' x 5'		BLUE	WHITE	WHITE	WHITE
MPT-10	8' x 4'	TOLL PLAZA AREA CONSTRUCTION	ORANGE	BLACK	BLACK	_____

SIGN	SIZE	LEGEND	BACK-GROUND	COPY	BORDER	ARROWS
MPT-31	8' x 4'	NO SHOULDER NEXT __ MILES	ORANGE	BLACK	BLACK	_____
MPT-34	4' x 3'	SHOULDER CLOSED	ORANGE	BLACK	BLACK	_____
MPT-36	4' x 4'	HEAVY EQUIPMENT CROSSING	ORANGE	BLACK	BLACK	_____
MPT-37	4' x 1.5'	CONSTRUCTION VEHICLE KEEP ALERT FOR SUDDEN STOPS AND TURNS	ORANGE	BLACK	_____	_____
MPT-38	4' x 4'	LEFT SHOULDER LOW	ORANGE	BLACK	BLACK	_____
W1-4CL	4' x 4'		ORANGE	BLACK	BLACK	BLACK
W1-4CR	4' x 4'		ORANGE	BLACK	BLACK	BLACK
PTC-LC	4' x 4'	LANE CLOSED	ORANGE	BLACK	BLACK	_____
PTC-LCA	4' x 4'	LANE CLOSED AHEAD	ORANGE	BLACK	BLACK	_____

GENERAL NOTES:

1. PROVIDE ALL OTHER SIGNS PER PENNDOT PUB. 236 AND SIZED AS INDICATED FOR EXPRESSWAYS AND INTERSTATES.
2. PROVIDE SIGNS WITH PENNDOT TYPE XI REFLECTIVE SHEETING MATERIAL. BLACK LEGEND AND BORDER IS NON-REFLECTIVE.
3. EXISTING MPT-07 AND MPT-08 MAY ONLY BE USED FOR THE REMAINDER OF THEIR SERVICEABLE LIFE.

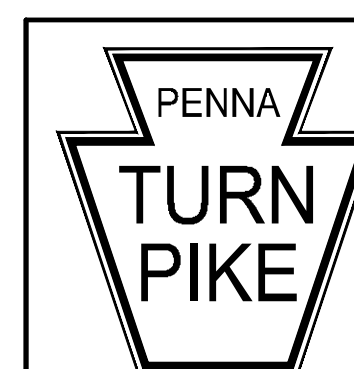

RECOMMENDED: DECEMBER 31, 2019
Gayle Gilman
 ASSISTANT CHIEF ENGINEER - DESIGN
 APPROVED: DECEMBER 30, 2019
[Signature]
 CHIEF ENGINEER

**CONSTRUCTION AND MAINTENANCE
 MAINTENANCE AND PROTECTION OF TRAFFIC
 GENERAL NOTES AND TABULATION OF SIGNS**

**PENNSYLVANIA TURNPIKE COMMISSION
 STANDARD DRAWING**

FILE NAME: PTS-960-4.dwg	SHEET 4 OF 5
DRAWING TYPE: 5A	
DATE: DECEMBER 2019	PTS-960

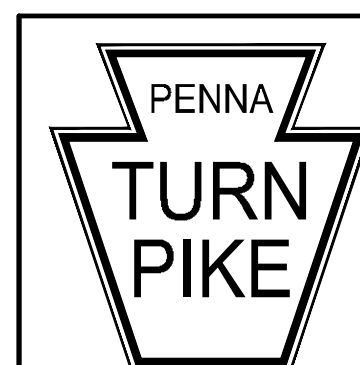
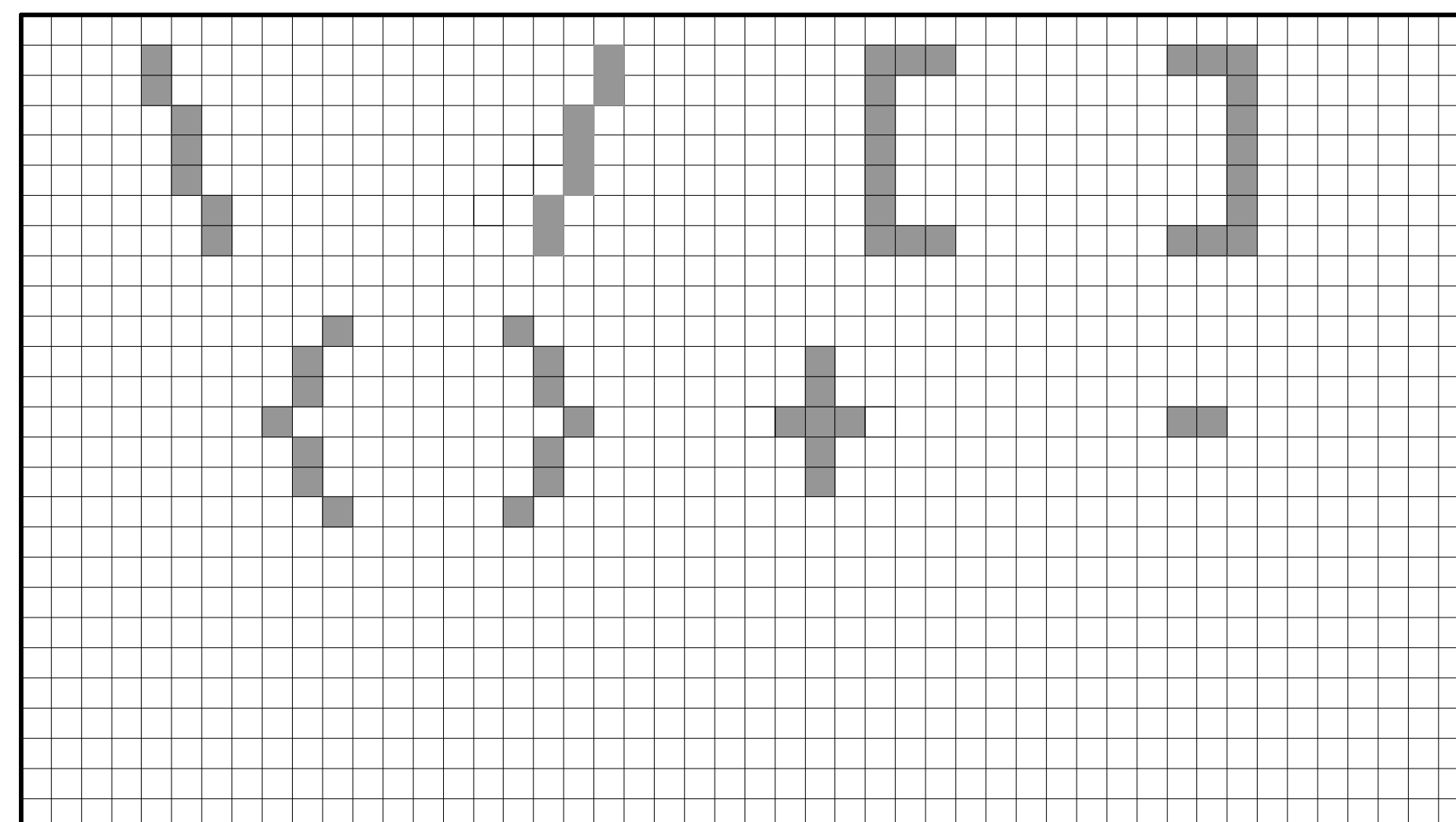
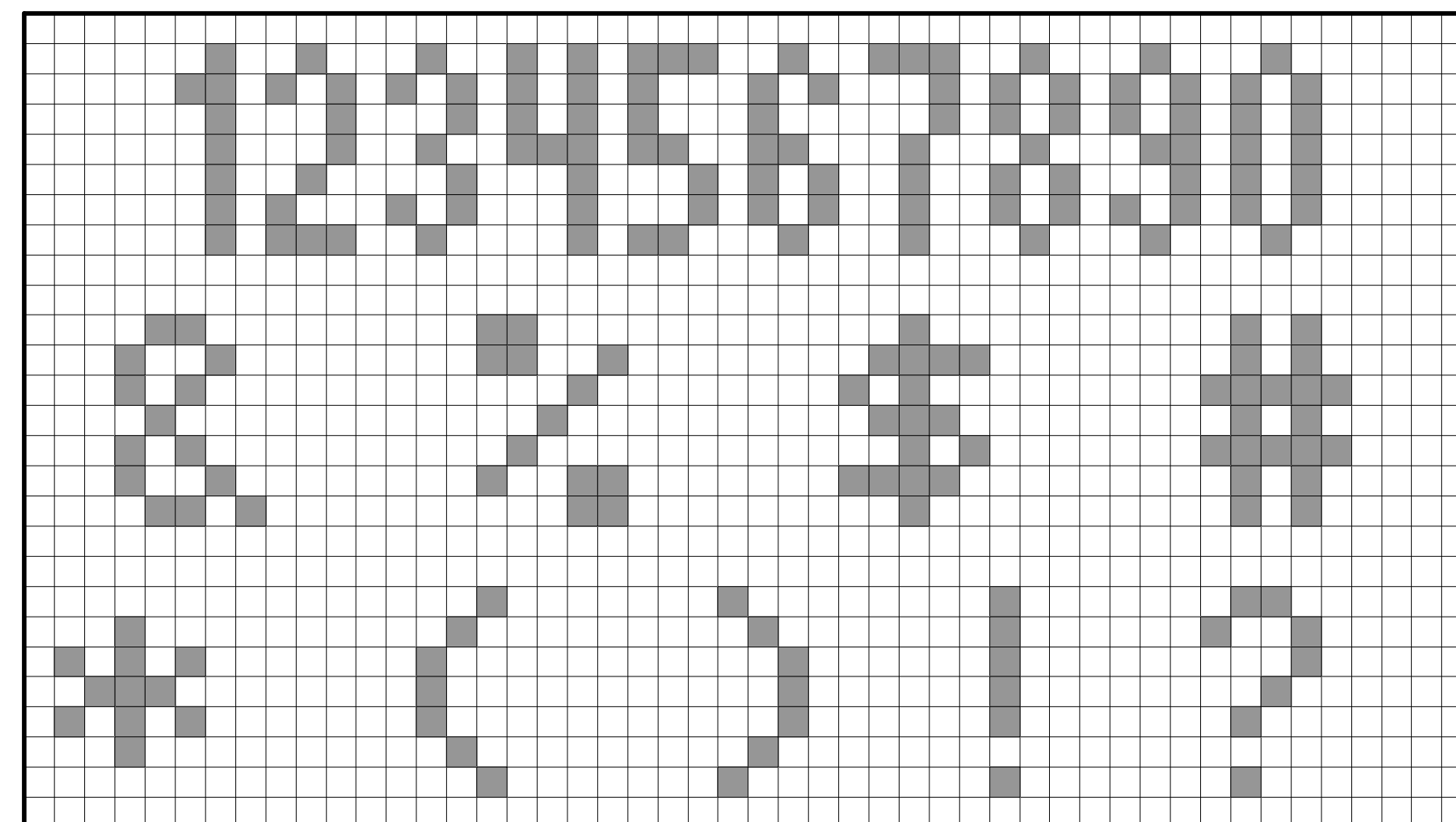
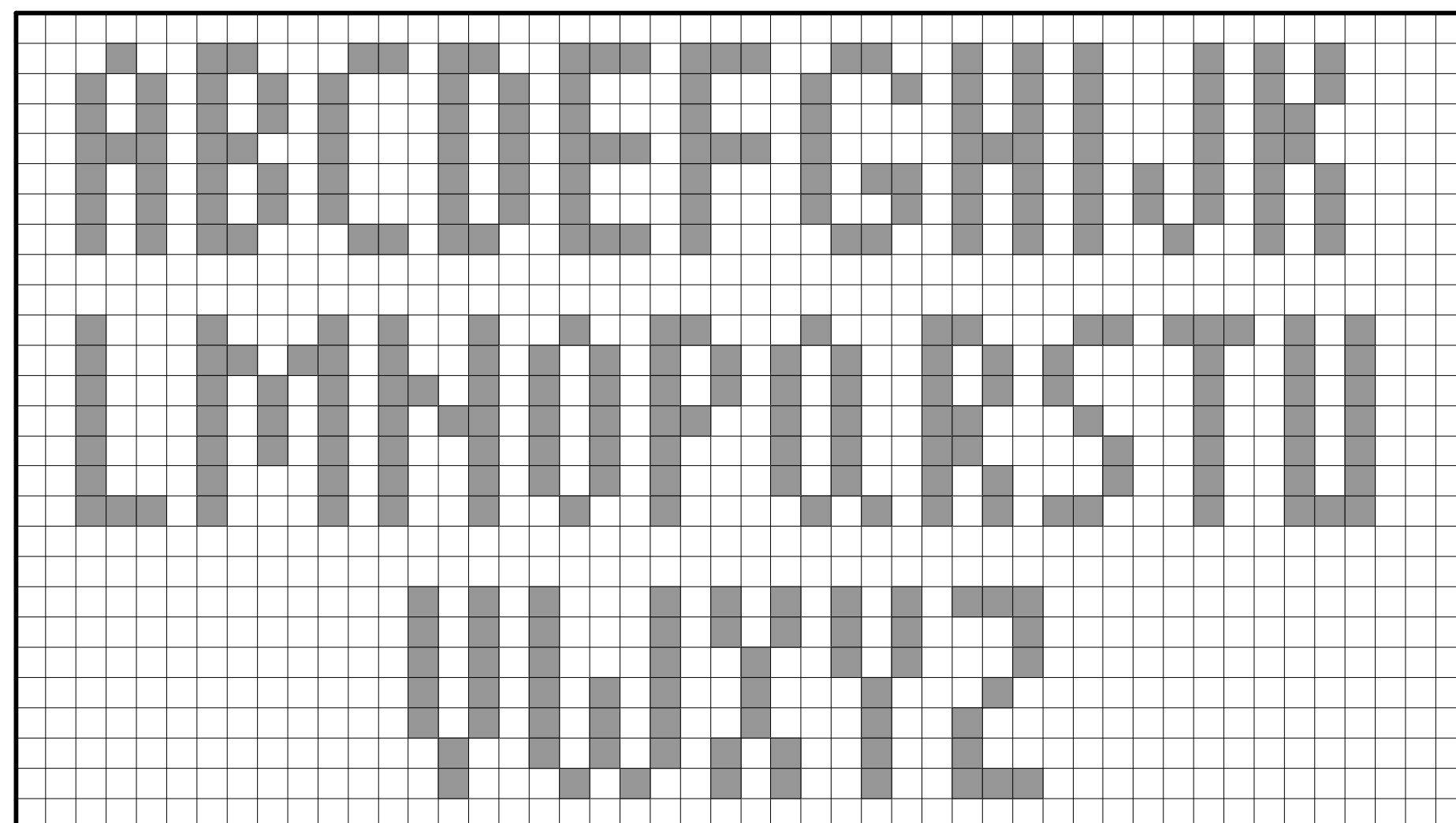

RECOMMENDED: DECEMBER 31, 2019
Gayle J. Gilman
ASSISTANT CHIEF ENGINEER - DESIGN
APPROVED: DECEMBER 30, 2019
[Signature]
CHIEF ENGINEER

CONSTRUCTION AND MAINTENANCE
MAINTENANCE AND PROTECTION OF TRAFFIC
PCMS CONDENSED FONT DETAILS

PENNSYLVANIA TURNPIKE COMMISSION
STANDARD DRAWING
FILE NAME: PTS-960-5.dwg
DRAWING TYPE: 5A
DATE: DECEMBER 2019
SHEET 5 OF 5
PTS-960